

Efficacy of the Pulse Pressure Generator during Cardiopulmonary Bypass Training Using the Extracorporeal Circulation Simulator

Shigeru MINAMI^{1,*}, Tatsuya KUROSAKI¹, Shinji NINOMIYA², and Taijiro SUEDA¹

1) Department of Surgery, Graduate School of Biomedical Sciences, Hiroshima University, Hiroshima, Japan

2) Department of Clinical Engineering, Hiroshima International University, Hiroshima, Japan

ABSTRACT

Objective: Cardiopulmonary bypass during cardiac surgery is an essential procedure, and the perfusionist needs to have sufficient education and training. Simulation training is suitable in such cases. We have developed a simulation system for cardiopulmonary bypass training (extracorporeal circulation simulator [ECCSIM]) and reported its efficacy. ECCSIM had no pulse pressure generator, so some perfusionists have mentioned that the operational feeling during training differs from that in real clinical cases.

In this study, we have developed a new pulse pressure generator and examined the efficacy of this system during cardiopulmonary bypass training using ECCSIM.

Materials and Methods: Results were observed as wave patterns during simulation of extracorporeal circulation with and without pulse pressure flow. Operational feeling during training of extracorporeal circulation was compared using a questionnaire survey, based on the Japanese version of the NASA Task Load Index (NASA-TLX), a subjective index, completed by seven perfusionists.

Results: With the addition of pulse pressure flow, fluctuation of arterial flow at low speed with the centrifugal pump increased, and operation of extracorporeal circulation became unstable. The questionnaire survey, including 'Operational feeling of centrifugal pump', 'Feeling of afterload', and 'Display of pressure monitor', showed results similar to that of the clinical situation using pulse pressure flow. The difficulty of simulator operation in extracorporeal circulation was significantly greater in the group with pulse pressure flow. Mental/physical load examined with NASA-TLX increased with pulse pressure flow.

Conclusion: Using a new pulse pressure generator with ECCSIM was effective in extracorporeal circulation training.

Key words: cardiopulmonary bypass training, simulation, pulse pressure, NASA-TLX

INTRODUCTION

Cardiopulmonary bypass during cardiac surgery is an essential procedure related to stabilisation of haemodynamic status. Failure of cardiopulmonary bypass risks the patient's life. The perfusionist needs to have sufficient education and training to safely operate the cardiopulmonary bypass machine. However, unified methods for training or education are currently lacking, and operators are trained at each facility by receiving guidance within clinical cases in Japan. Many limitations to clinical skill training are seen for students or novice perfusionists, since there are sufficient opportunities for clinical experience. Simulation training, which reproduces the structure and functions of the human body, is effective in such cases. The advantages of simulation education are that anyone can have safe education, training is easily repeated, and the level of difficulty can be

increased according to the proficiency. In addition, the level of achievement can also be evaluated²¹). Compared to Europe and America, simulation training is not widely used in Japan. In particular, the introduction of simulation training in the field of cardiopulmonary bypass lags significantly behind other fields⁶).

We have developed a simulation system, extracorporeal circulation simulator (ECCSIM), for cardiopulmonary bypass training, implemented experimental adaptations targeted at experienced clinicians and students, and reported the efficacy of this system^{16-18,24-26}). Due to concerns about the size and cost of the system, a pulse pressure generator was not initially built into the ECCSIM.

Since the introduction of the ECCSIM, some perfusionists have mentioned that the operational feeling during the simulation somewhat differs from that in real clinical situation²⁵). We therefore developed a compact, simplified pulse pressure generator for use with the ECCSIM to address this problem. The efficacy of simulation

* Corresponding author: Shigeru Minami

Department of Surgery, Graduate School of Biomedical Sciences, Hiroshima University, 1-2-3 Kasumi, Minamiku, Hiroshima 734-8551, Japan

E-mail: shigeru373@hotmail.com

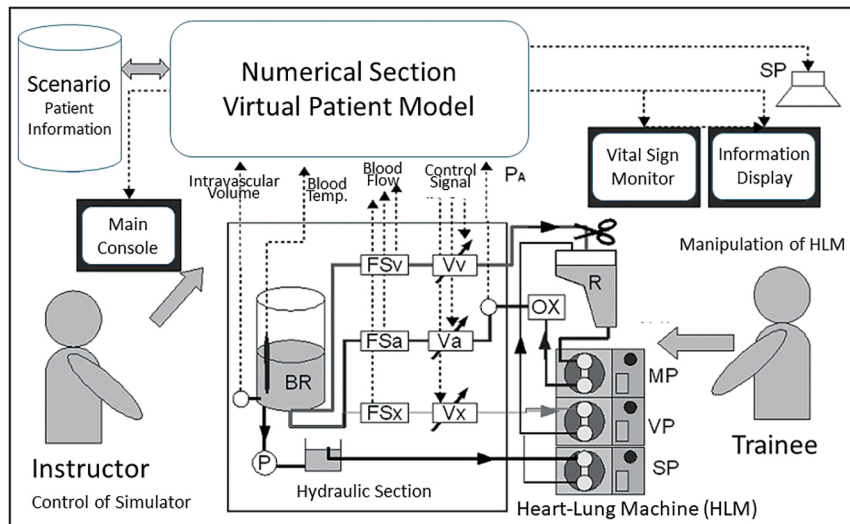

Figure 1 Schematic of the ECCSIM.

training and the realistic feeling during operation with and without pulse pressure flow have not been evaluated. This study therefore examined simulation training in centrifugal pump operation and evaluated the effect of pulse pressure reproduction during cardiopulmonary bypass operation and how it would affect the simulation quality. A questionnaire survey was utilised to evaluate differences in subjective perceptions of operations. Furthermore, to analyse the effects of the difficulty of the cardiopulmonary bypass operation, the Japanese version of the NASA Task Load Index⁷⁾ (NASA-TLX) was utilised as a subjective index.

MATERIALS AND METHODS

The ECCSIM virtual patient simulator

We developed a high-fidelity virtual patient simulation system aimed at training and education in the operation of cardiopulmonary bypass machines. ECCSIM consists of built-in software with a virtual patient model reproducing haemodynamic and metabolic conditions, scenario, and simulated patient information, and simulated circulation set that transfers information such as arterial line pressure (arterial pressure), arterial flow, venous drainage flow, and circulation volume, which change according to the operation of the cardiopulmonary bypass machine (Figure 1).

Pulse pressure generator

The virtual patient simulation system, ECCSIM, used in a previous study, can reproduce arterial line pressure arbitrarily by adjusting the proportional control electromagnetic valve set on the arterial line¹⁷⁾. However, with this method, reproducing a situation close to the clinical situation is difficult when using centrifugal pump as the arterial pump, since the arterial line pressure depends on the arterial pump flow and line resistance¹⁸⁾. Using the elevation difference between the patient-side reservoir and pump is one solution to this problem, but pulse pressure similar to the clinical situation cannot be generated. Therefore, a new pulse pressure generator is instal-

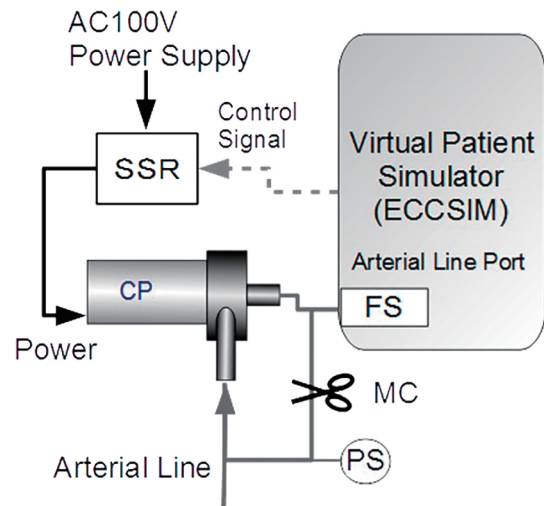

Figure 2 Schematic of the arterial line pressure generator.

led on the ECCSIM in this study.

The structure of the pulse pressure generator developed in this study is shown in Figure 2.

The device generates arterial line pressure by setting the outlet port of a centrifugal pump (Magnet Pump CPM-20FH; Nikkiso Eiko Co., Ltd., Tokyo, Japan), facing the direction of the arterial line, regardless of the pump's arterial flow. The arterial line pressure was used as the input value, and arterial pressure from the virtual patient simulation model was used for the target value; using feedback control of the centrifugal pump speed, arterial pressure similar to the human body can be generated.

As the speed of the pump's power source (AC induction motor) is determined by the frequency of the commercial AC power supply, we modified the regulating program of the virtual patient simulation system (ECCSIM-X version 0.2.3) using the algorithm indicated in Figure 3. The centrifugal pump (Magnet Pump CPM-20FH, Nikkiso Eiko Co., Ltd.) was regulated by pulse width modulation control from the cardiopulmonary bypass simulator computer via the phototriac device (MOC3041), and we experimentally developed a

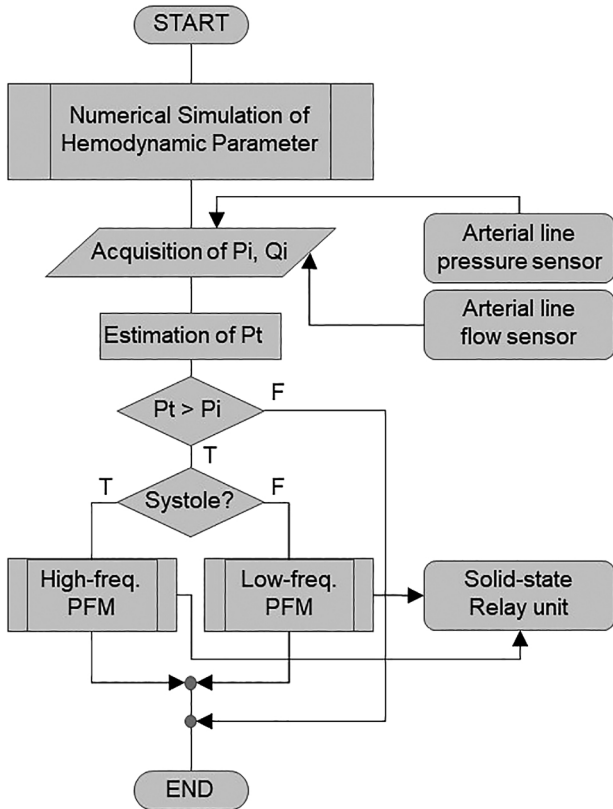

Figure 3 Flowchart for the arterial line pressure-regulating program.

function that generates pulse pressure to the arterial line similar to the patient’s blood pressure signal calculated by the simulation model. Furthermore, a bypass channel was set to improve the reduction in response to the arterial line pressure.

Figure 4 shows a comparison between the virtual arterial pressure calculated by the virtual patient simulation system and actual arterial pressure generated by this system. Although a response time delay of 0.1~0.2 s was seen, the difference in actual and calculated values of

Table 1 Subject characteristics.

| | | |
|--------------------------------------|--------------|---------------------------------|
| Number | 7 persons | Male : female = 4 : 3 |
| Years of experience | 11.9±6.7 yrs | Min: 5 yrs, Max: 23 yrs |
| Certified for CCP (JPN) | 7 persons | 100 % |
| Number of CPB cases in the past year | 37±11 cases | Min: 23 cases, Max: 50 cases |

systolic and diastolic pressures were confirmed to be within 10% each.

Subjects

The subjects in this study were seven perfusionists who were proficient in cardiopulmonary bypass operation from a single institution (Table 1).

Heart-lung machine

The heart-lung machine used in this study was a device routinely operated by the subjects (Stockert S111 Heart-Lung Machine; LivaNova Deutschland GmbH, München, Germany).

For the circulation set, a tubing set (arterial line and venous drainage line), membrane oxygenator with integrated venous reservoir (Affinity NT; Medtronic, Minneapolis, MN, USA), and centrifugal pump (Revolution Pump, Sorin Group Italia S.r.l., Mirandola, Italy; Stockert SCP, LivaNova Deutschland GmbH, München, Germany) routinely operated by the subjects were utilised.

Simulation scenario

The following three training scenarios were utilised. To examine the effect of the presence of pulse pressure flow, arterial flow, venous drainage flow and waveform,

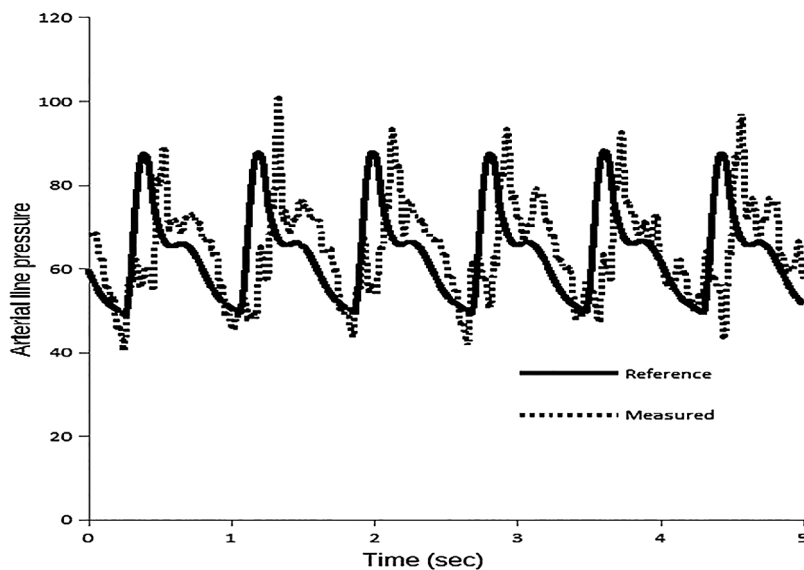

Figure 4 Comparison of measured arterial pressure change and target value.

arterial pressure and waveform, arterial line pressure, and venous reservoir level were observed.

1) Scenario 1: Training to increase or decrease arterial flow rate while maintaining the venous reservoir level. Scenario 1 was carried out in the three phases described below, with the elapsed time reported every 10 s. Subjects are required to maintain venous reservoir level at 500 mL from the start of arterial flow until the pump is stopped.

Phase 1: Increase flow rate to the target flow (4.5 L/min) for 1 min.

Phase 2: Maintain flow (fix the centrifugal pump speed) for 30 s after reaching the target flow.

Phase 3: Stop the pump 1 min after maintaining the target flow rate.

2) Scenario 2: Training to increase or decrease arterial flow rate while maintaining blood pressure

Scenario 2 was carried out in the three phases described below, with the elapsed time reported every 10 s. Subjects are required to maintain blood pressure constant from the start of arterial flow until the pump is stopped.

Phase 1: Increase flow rate to the target flow (4.5 L/min) for 1 min.

Phase 2: Maintain flow (fix the centrifugal pump speed) for about 2 min after reaching the target flow.

Phase 3: Stop the pump 1 min after maintaining the target flow rate.

3) Scenario 3: Training in changing the afterload by adjusting venous flow

Scenario 3 was carried out in the seven phases described below, with the elapsed time reported every 10 s.

Phase 1: Increase the flow rate to the target flow (4 L/min) for 30 s while maintaining the venous reservoir level at 500 mL.

Phase 2: Maintain flow (fix the centrifugal pump speed) for 30 s after reaching the target flow while keeping the venous reservoir level at 500 mL.

Phase 3: Increase the venous reservoir level from 500 mL to 1,500 mL for 30 s while maintaining the speed of the centrifugal pump.

Phase 4: Keep the venous reservoir level at 1,500 mL while maintaining the speed of the centrifugal pump.

Phase 5: Return the venous reservoir level to 500 mL for 30 s while maintaining the speed of the centrifugal pump.

Phase 6: Keep the venous reservoir level at 500 mL while maintaining the speed of the centrifugal pump.

Phase 7: Stop the pump 30 s after maintaining the target flow rate while keeping the venous reservoir level at 500 mL.

Questionnaire survey

A questionnaire was completed by all simulation trainees. The contents of the questionnaire included number of years of clinical experience, qualifications of the certified clinical perfusionist, number of clinical cases for the past year, operational feeling for cardiopulmonary bypass between this simulation and clinical situation, and open-ended impressions. Questions relating to the operational feeling of the simulation and clinical situa-

tion included 'Is the arterial line pressure close to the clinical setting?', 'Is the speed of the centrifugal pump close to the clinical setting?', and 'Is the monitor display close to the clinical setting?' for both with and without pulse pressure flow. The questionnaire responses were selected from among 'Unlikely', 'Somewhat unlikely', 'Somewhat likely', and 'Likely', with weighting coefficients of -1, -1, 1, and 1, respectively, applied for the results and displayed as a graph. To examine operational feelings with the addition of pulse pressure flow, the question 'At which phase did the operation feel different from the clinical situation?' was added. The answer was a selection from 'Initial', 'Maintain', 'Weaning', 'None', and 'Not sure', with weighting coefficients of -1, -1, -1, 1, and 1, respectively, for the result. Furthermore, the degree of each difficulty with or without pulse pressure flow was investigated by plotting a 0–100 scale.

Subjective index (Japanese version of NASA-TLX)

To examine the effects of mental workload with the presence of pulse pressure flow, the evaluation index of the Japanese version of NASA-TLX was used. Each evaluation index was filled in by all simulation trainees accompanied by the investigator (Table 3). The weighted workload (WWL) of the Japanese version of NASA-TLX was calculated by pairwise comparison of the importance of the scales (category weighting factor) (Table 2).

Each of the scores for Mental Demand (MD), Physical Demand (PD), Temporal Demand (TD), Own Performance (OP), Effort (EF), Frustration (FR), and Overall Workload (OW) was converted to a score of 0 to 100.

Methods of statistical analysis

WWL was calculated using each evaluation value (MD, PD, TD, OP, EF, and ER). The Wilcoxon signed-rank test was used for all 8 workload factors, with P-value < 0.05 considered statistically significant.

The Wilcoxon signed-rank test was used for the questionnaire on the presence of pulse pressure flow to compare difficulty levels. All statistical analyses were performed with EZR¹⁰ version 1.36 (Saitama Medical Center, Jichi Medical University, Saitama, Japan), which is a graphical user interface for R (The R Foundation for Statistical Computing, Vienna, Austria).

RESULTS

Wave pattern observation by scenario

- 1) Scenario 1: In training without pulse pressure flow, fluctuation of arterial flow was low while increasing/decreasing and maintaining the arterial flow, and the operation was completed within the set time. In training with pulse pressure flow, arterial flow was unstable in the early stage and before the end, when the speed of the centrifugal pump was low, and the operation was not completed within the set time, delaying each phase (Figure 5a).
- 2) Scenario 2: In training without pulse pressure flow, arterial flow was smoothly increased or decreased,

Table 2 Japanese version of the NASA-TLX.

| Work Load | MD | PD | TD | OP | EF | FR |
|------------------------------------|----|----|----|----|----|----|
| Mental Demand vs Physical Demand | | | | | | |
| Mental Demand vs Temporal Demand | | | | | | |
| Mental Demand vs Performance | | | | | | |
| Mental Demand vs Effort | | | | | | |
| Mental Demand vs Frustration | | | | | | |
| Physical Demand vs Temporal Demand | | | | | | |
| Physical Demand vs Performance | | | | | | |
| Physical Demand vs Effort | | | | | | |
| Physical Demand vs Frustration | | | | | | |
| Temporal Demand vs Performance | | | | | | |
| Temporal Demand vs Effort | | | | | | |
| Temporal Demand vs Frustration | | | | | | |
| Performance vs Effort | | | | | | |
| Performance vs Frustration | | | | | | |
| Effort vs Frustration | | | | | | |
| Count(X:1-5) | | | | | | |

Table 3 Japanese version of NASA Task Load Index (TLX).

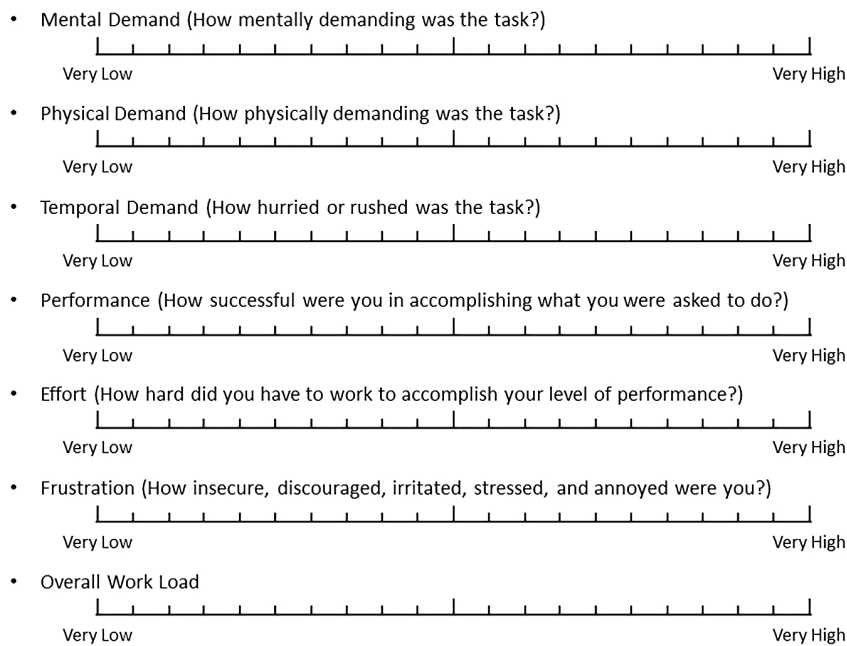

and the fluctuation of blood pressure was low, within 10%. In training with pulse pressure flow, arterial flow became unstable in the early stage and before the end, and higher fluctuations of arterial flow were observed. Due to this, fluctuations of blood pressure when increasing or decreasing arterial flow were high, about 20% (Figure 5b).

3) Scenario 3: In training without pulse pressure flow, circuit pressure was ‘static pressure’ before pump start and after pump stop, and no afterload was present. Circuit pressure during Phases II to VI was also constant because no pulsatile pressure actually occurred. In Phase 4, as drainage from the vein increased, the calculated arterial pressure decreased, but circuit pressure remained constant. Afterload thus did not

change and arterial flow remained constant. In training with pulse pressure flow, arterial and circuit pressures were approximately the same before pump start and after pump stop. In Phase 4, as drainage from the vein increased, the calculated arterial pressure decreased, and circuit pressure decreased accordingly. Although pump speed remained constant, arterial flow increased as afterload decreased (Figure 5c).

Questionnaire

Regarding the question ‘Is the operational feeling of the centrifugal pump close to the clinical situation?’, 85.7% of subjects performing training with pulse pressure flow answered ‘yes’, compared to 0% performing training without pulse pressure flow (Figure 6a). Simi-

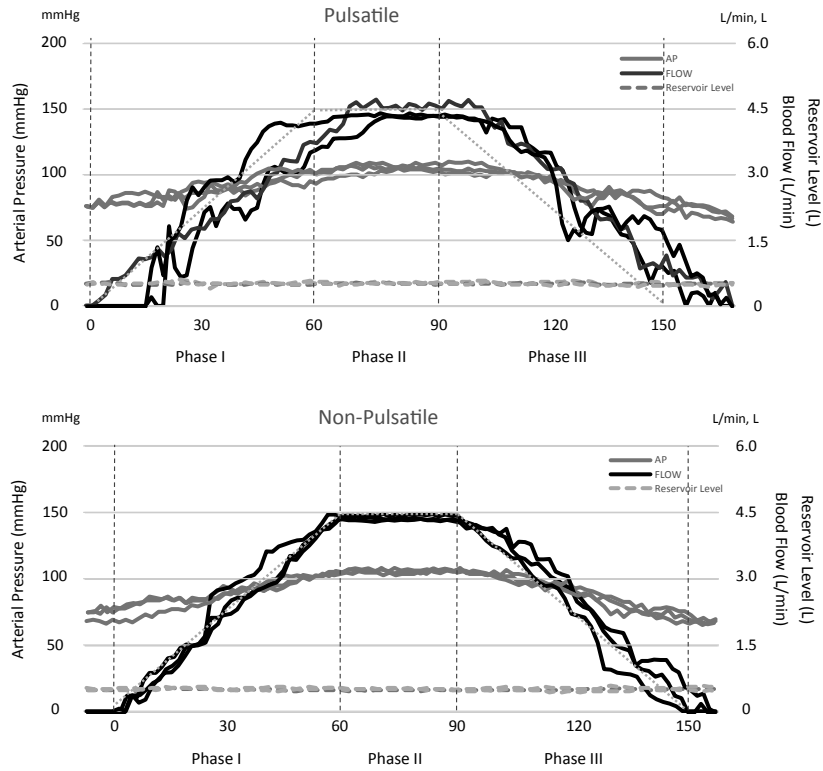

Figure 5a Scenario 1.

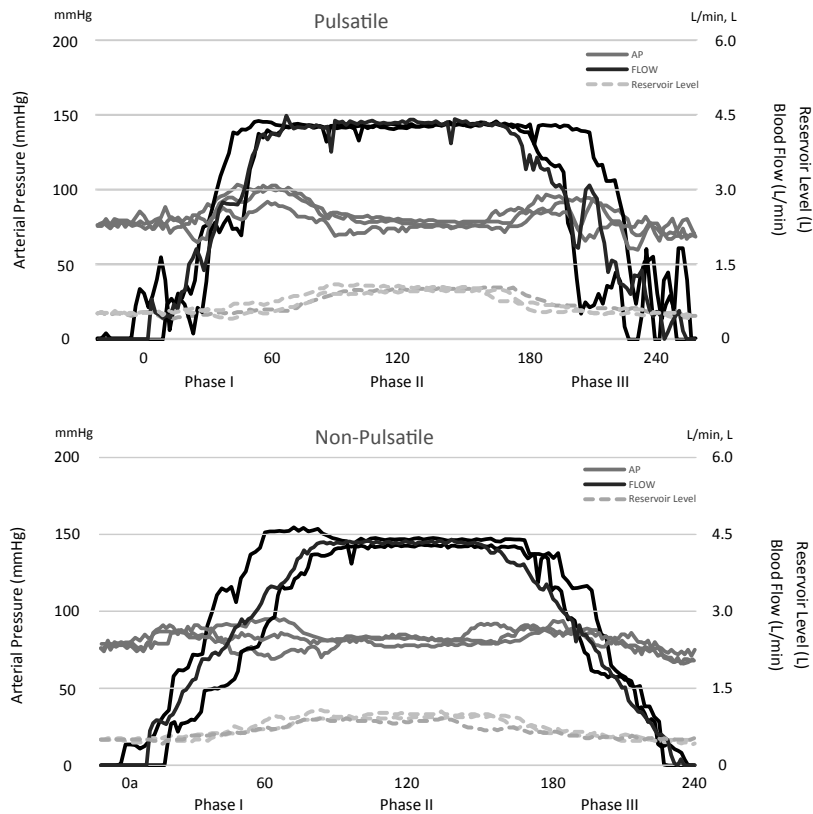

Figure 5b Scenario 2.

larly, ‘yes’ was the answer to ‘Is the arterial line pressure close to the clinical situation?’ in 100% of subjects performing training with pulse pressure flow and 28.6% performing training without pulse pressure flow (Figure 6b) and to ‘Is the monitor display close to clinical situation?’ in 85.7% performing training with pulse pressure

flow and 0% performing training without pulse pressure flow (Figure 6c).

To the question ‘At which phase did the operation feel different than the clinical situation?’, 28.6% answered ‘Introduction’, while 57.1% answered ‘Weaning’. This result clearly revealed differences in the simulation and

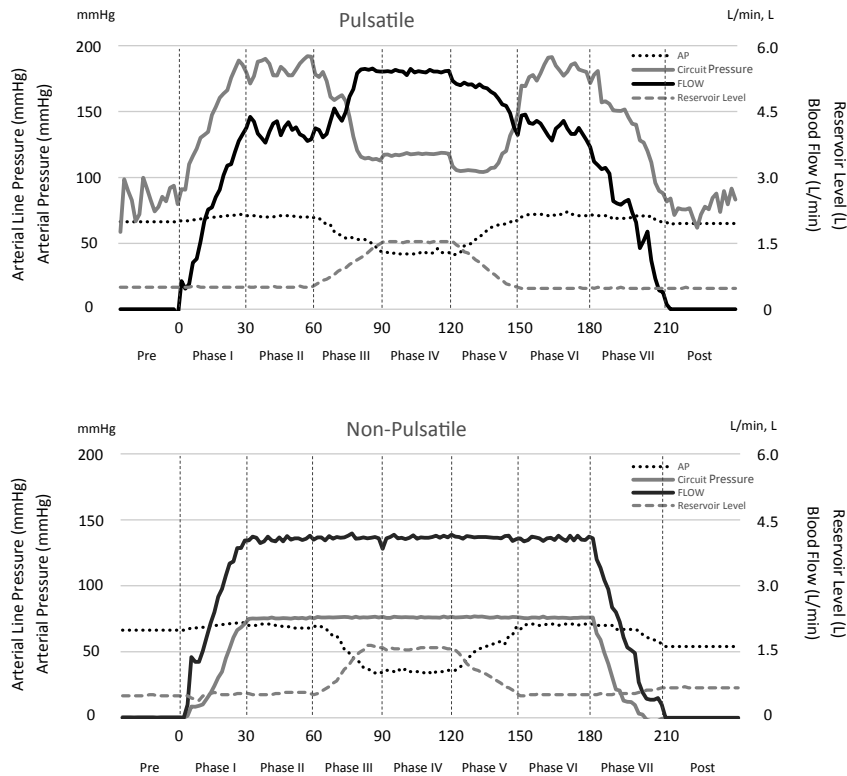

Figure 5c Scenario 3.

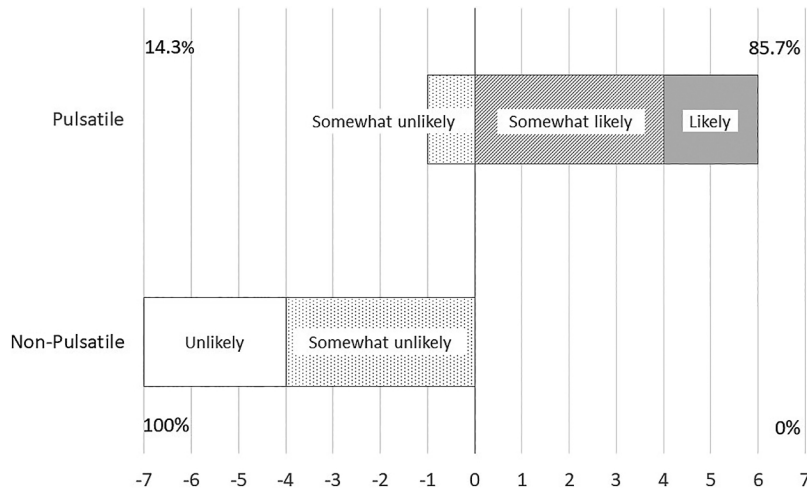

Figure 6a Is the operational feeling of the centrifugal pump close to clinical use?

clinical situation when changing arterial flow. In training with pulse pressure flow, only 1 trainee (14.3%) reported that operational feeling was different at the introduction, but 85.7% stated that the operational feeling was close to the clinical situation (Figure 6d).

The degree of difficulty of the training with pulse pressure flow was significantly higher than that without pulse pressure flow (Figure 7).

Other comments from trainees were as follows: ‘The relationships between centrifugal pump speed, blood pressure, and flow were reproducible’, ‘The instability of flow rate at low speeds was close to clinical situation’, ‘The relationship between volume and pressure was close to clinical situation’, and ‘This is suitable for training in centrifugal pump operation’. The impression was that

the simulation with pulse pressure flow more closely mimicked the feeling of the clinical situation compared to simulation without pulse pressure flow. In contrast, other comments included ‘Too much afterload’ and ‘Flow control was difficult because large fluctuations in blood pressure occurred with small changes in volume’, mentioning that having a pulse pressure that was too high was unnatural.

Subjective index

In the comparison of mental workload from the Japanese version of NASA-TLX, WWL was significantly higher with pulse pressure flow than without pulse pressure flow ($Z = -3.09, p = 0.0020$). Each evaluation item was also significantly higher with pulse pressure flow

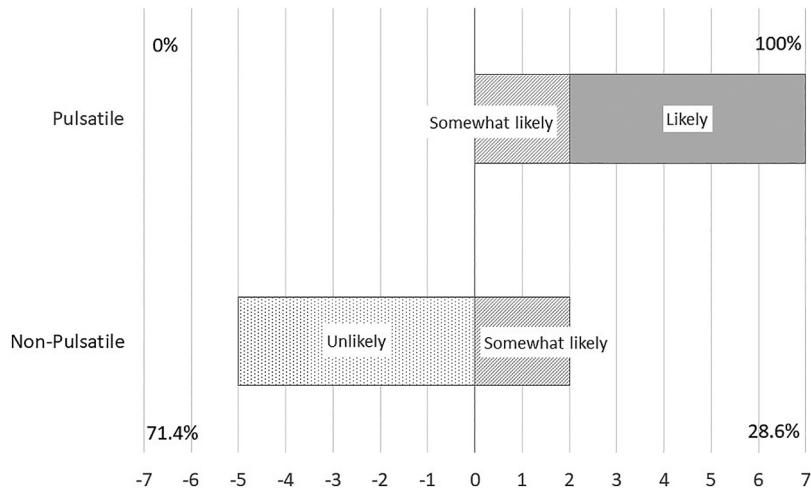

Figure 6b Does circuit pressure (afterload) match clinical practice?

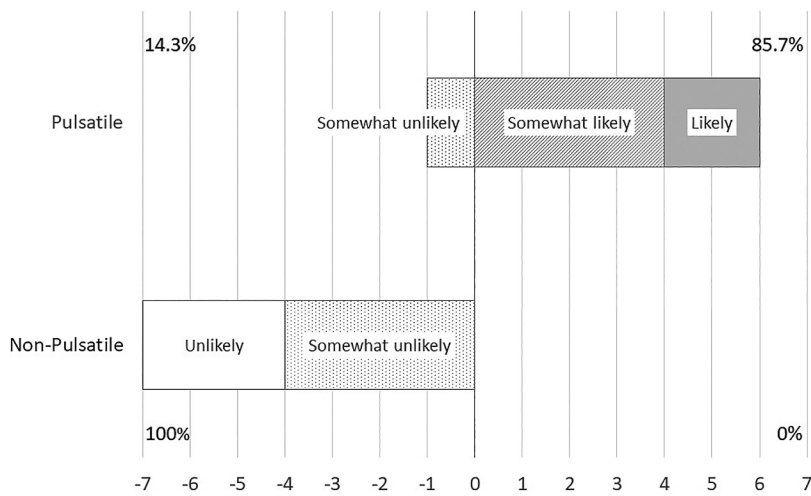

Figure 6c Does the monitor display match the clinical practice?

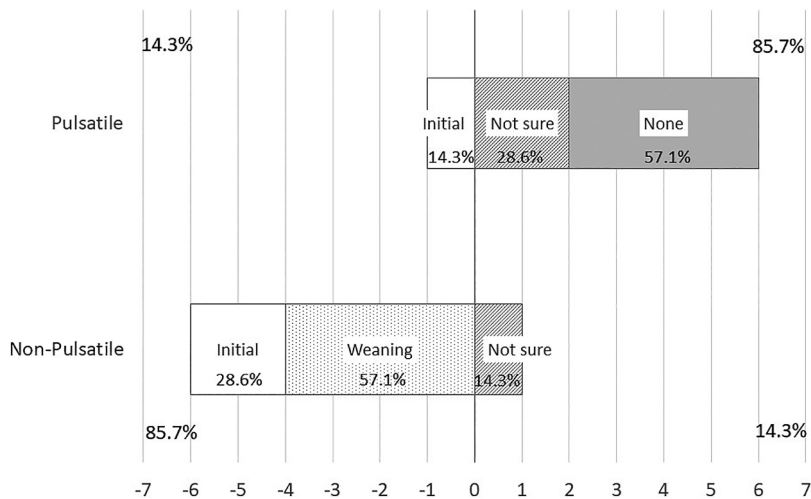

Figure 6d Which phase is different from the clinical operational feeling?

(PD, $Z = -2.18$, $p < 0.05$; TD, $Z = -1.99$, $p < 0.05$; EF, $Z = -2.88$, $p < 0.01$; FR, $Z = -2.82$, $p < 0.01$). Furthermore, OW was significantly higher with pulse pressure flow than without ($Z = -3.07$, $p < 0.01$) (Figure 8).

DISCUSSION

Pumps used for extracorporeal circulation are roughly classified into two types: centrifugal pumps and roller pumps. In most facilities, roller pumps have been used for extracorporeal circulation. They can forcibly send a certain volume of blood, but high pressure may arise if

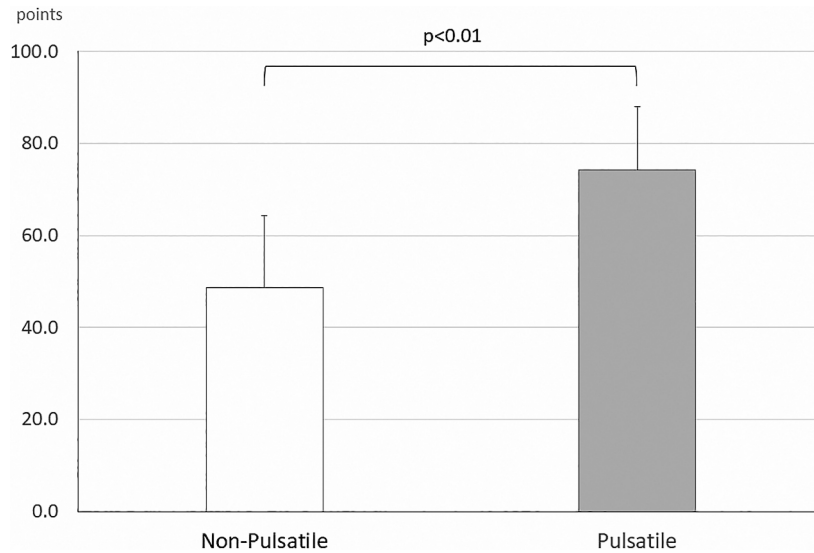

Figure 7 Comparison of difficulty between pulsatile and non-pulsatile flow.

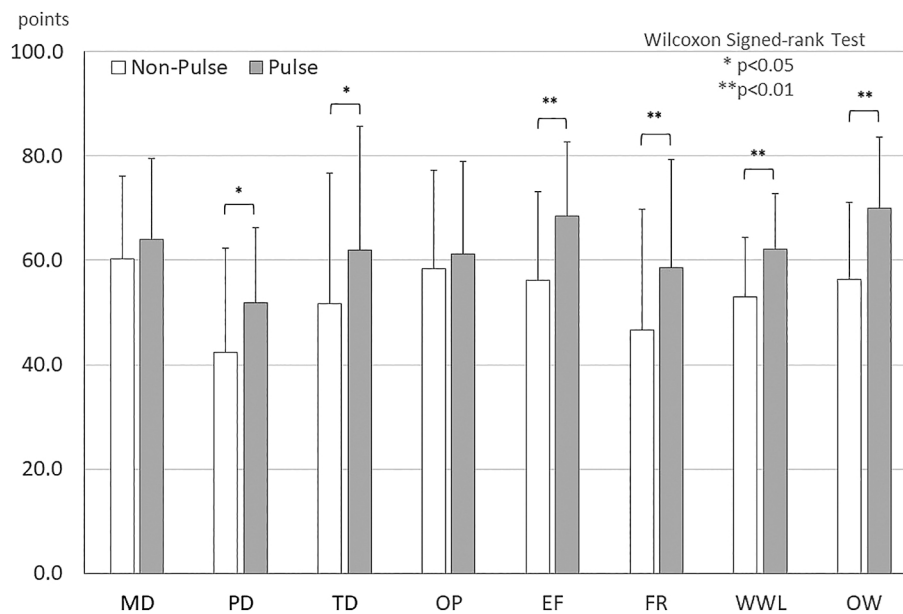

Figure 8 NASA-TLX.

the circuit becomes blocked or air may be pumped erroneously. From the perspective of ensuring safety, use of centrifugal pumps has recently been increasing. Centrifugal pumps offer many advantages compared with roller pumps³⁹: 1) high pressure does not occur even when the pump is blocked; 2) air is highly unlikely to be sent erroneously; 3) excessive negative pressure is not produced; 4) no abrasive particles are generated from friction against the inner surface of the tube; and 5) they have a compact and highly portable design. However, even if the centrifugal pump is operated at the same rotation speed, flow changes as afterload changes. To keep pump flow constant, the flow meter must be monitored and rotational speed maintained at all times. Furthermore, if an erroneous operation is performed, dangerous back-flow may occur due to the pulsatile pressure flow, so training with pulsating pressure flow is necessary.

Some cardiopulmonary bypass simulators with an integrated pulse generator have been marketed^{15,20}. The

structures of these systems are complicated, and the cost is high. Further, the degree to which the existence of pulse pressure flow affects the simulation is unclear. For this reason, the ECCSIM in the early stage of development did not have an integrated pulse generator.

In this study, we integrated a simple, low-cost pulse pressure generator with the ECCSIM. Using this system, we evaluated whether the operational feeling in clinical situations can be mimicked and whether the subjective index would be changed (mental workload).

In Scenarios 1 and 2, representing training to increase or decrease arterial flow rate while maintaining the venous reservoir level and training to increase or decrease arterial flow rate while maintaining blood pressure, arterial flow became unstable at pump start and before pump stop with pulse pressure flow. Since the lift generated by the pump is small when rotation speed of the centrifugal pump is low, arterial flow is affected by the pulse pressure flow. After the rotation speed of the

centrifugal pump becomes high and lift increases, arterial flow is unaffected by pulse pressure flow, and arterial flow became stable.

Scenario 3 examined the change in afterload on the operation of extracorporeal circulation and its effects on arterial flow. In the simulation without pulse pressure flow, no actual pressure is generated. Afterload was also calculated and not actually found to occur. Therefore, although afterload should be changing, it does not affect the actual operation at all, since the actual pressure has not changed. Even if the trainee makes a mistake with the operation, no backflow to the pump will occur. This may be the cause of the trainees gaining an impression that the experience is 'different from the clinical situation'. By generating an actual pulse pressure flow inside the circuit, the influence on arterial flow can be reproduced due to the change in afterload and could closely resemble the clinical situation.

From the questionnaire results, many trainees perceived that the operational feeling in training with pulse pressure flow with the centrifugal pump was close to that in the clinical situation. In training without pulse pressure flow, many trainees felt uncomfortable at the time of introduction and weaning, which requires continued pump operation.

The NASA-TLX^{8,12)} was used to evaluate subjective impressions in this study and has been used to design aircraft cockpits, as a parameter to evaluate operability and mental workload of the pilot during a flight. Haga et al.⁷⁾ designed the Japanese version of the NASA-TLX and reported the potential adaptation to different experimental subjects. Even in operations with different properties, this index can extract changes in level of difficulty as WWL. NASA-TLX has also been used for research into mental workload during extracorporeal circulation¹¹⁾. In this study, we evaluated two patterns of operational feeling during simulations, with or without pulse pressure flow, and performed evaluations using the Japanese version of the NASA-TLX. Significant differences in WWL were obtained, revealing greater workload with pulse pressure flow compared to that without pulse pressure flow. Looking at the detailed evaluations, significant differences were also observed in PD, TD, EF, and FR. OW also showed a significant difference. This indicates that increases in mental and physical stress were achieved by adding pulse pressure flow to the extracorporeal circulation simulation. When pulse pressure flow is added to the increasing or decreasing flow rate, pulse pressure affects the output of the centrifugal pump, and flow rate swings from an antegrade to retrograde direction, making it difficult to adjust in a stable manner¹⁹⁾ and increasing the difficulty of the operation. Questionnaire results also suggested that the addition of pulse pressure flow raises the difficulty level, coinciding with results from the NASA-TLX.

In this study, training closer to the clinical situation could be performed by adding a pulse pressure generator to the ECCSIM. In particular, the effect was greater when a centrifugal pump was used, as one of the characteristics of centrifugal pumps is that flow rate changes with

afterload. Some centrifugal pumps have different flow characteristics, depending on the manufacturer and model²³⁾. When introducing a new pump for extracorporeal circulation, our system appears useful. The influence of roller pumps must be investigated in the future.

Seven perfusionists (certified clinical perfusionists) from a single centre who were experts in cardiopulmonary bypass operation were the subjects in this study. Evaluations with clinicians from multiple centres at different levels of expertise from beginner to expert are thus needed. Moreover, as the evaluation method in this study was obtained from the questionnaire survey, it is necessary to establish an objective evaluation method in the future.

Extracorporeal circulation simulation training is not only suitable for perfusionists. Reports have described the efficacy of extracorporeal circulation simulation training on cardiovascular surgeons and anaesthesiologists, as part of the cardiovascular surgery team^{1,2,4,5,9,13,14,22)}. An environment simulating the surgery field to practice cannulation for establishing extracorporeal circulation is necessary for cardiovascular residents²⁰⁾. Pulse pressure is mandatory, especially for aortic cannulation. By combining our system with heart, aorta, and vein models, training for cardiovascular surgeons and anaesthesiologists will also be possible in the future.

ANKNOWLEDGMENTS

We would like to express our gratitude to the staff perfusionists of Tokyo Women's Medical University Hospital for their assistance in the collection and registration of data and samples.

DISCLOSURE STATEMENT

All authors declare that they have no conflicts of interest.

(Received June 6, 2018)

(Accepted June 29, 2018)

REFERENCES

1. Brewer, Z.E., Ogden, W.D., Fann, J.I., Burdon, T.A. and Sheikh, A.Y. 2016. Creation and Global Development of a Mobile, Application-Based Cognitive Simulator for Cardiac Surgical Procedures. *Semin. Thorac. Cardiovasc. Surg.* 28(1): 1–9.
2. Bruppacher, H.R., Alam, S.K., LeBlanc, V.R., Latter, D., Naik, V.N., Savoldelli, G.L., et al. 2010. Simulation-based training improves physicians' performance in patient care in high-stakes clinical setting of cardiac surgery. *Anesthesiology.* 112(4): 985–992
3. De Soma, F.M.J.J. and Nooten, G.V. 2008. Blood Pumps in Cardiopulmonary Bypass, p.35–46; Safety Issues and Accidents with Pumps, p. 43–44. *In* Gravlee, G.P., *Cardiopulmonary Bypass: Principles and Practice* Third Edition, Philadelphia, Pa.; London: Lippincott Williams & Wilkins.
4. Feins, R.H., Burkhart, H.M., Coore, D.N., Conte, J.V., Fann, J.I., Hicks, G.L., et al. 2015. 1. Cardiopulmonary

- Bypass (CPB) Module, p. 3–18. *In* Cardiac Surgery Simulation Curriculum—Simulation-based training in surgical skills and decision making—, Thoracic Surgery Directors Association (TSDA).
5. Feins, R.H., Burkhart, H.M., Conte, J.V., Coore, D.N., Fann, J.I., Hicks, G.L., et al. 2017. Simulation-Based Training in Cardiac Surgery. *Ann. Thorac. Surg.* 103(1): 312–321.
 6. Fernandez, A. 2010. Simulation in perfusion: where do we go from here? *Perfusion.* 25(1): 17–20.
 7. Haga, S. and Mizukami, N. 1996. Japanese version of NASA Task Load Index: Sensitivity of its workload score to difficulty of three different laboratory tasks. *JJE (Japanese Journal of Ergonomics).* 32(2): 71–79.
 8. Hart, S.G. and Staveland, L.E. 1988. Development of NASA-TLX (Task Load Index); Results of empirical and theoretical research. p. 139–183. *In* P.A. Hancock and N. Meshkati (eds.), *Human mental workload.* North Holland.
 9. Hicks Jr., G.L., Gangemi, J., Angona Jr., R.E., Ramphal, P.S., Feins, R.H. and Fann, J.L. 2011. Cardiopulmonary bypass simulation at the Boot Camp. *J. Thorac. Cardiovasc. Surg.* 141(1): 284–292
 10. Kanda, Y. 2013. Investigation of the freely available easy-to-use software ‘EZ’ for medical statistics. *Bone Marrow Transplantation.* 48: 452–458. advance online publication 3 December 2012; doi: 10.1038/bmt.2012.244
 11. Kudo, T. and Ueki, S. 2013. A study of the mental workload evaluation of cardiopulmonary bypass operation—Effects on the mental workload of reservoir level—. *Japanese J. Extra Corpor. Technol.* 40(4): 478–486.
 12. Miyake, S. and Kumashiro, M. 1993. Subjective mental workload assessment technique—An introduction to NASA-TLX and SWAT and a proposal of simple scoring methods—. *Japanese J. Ergonomics.* 29(6): 399–408.
 13. Mokadam, N.A., Fann, J.I., Hicks, G.L., Mesbitt, J.C., Burkhart, H.M., Conte, J.V., et al. 2017. Experience with the Cardiac Surgery Simulation Curriculum. *Ann. Thorac. Surg.* 103(1): 322–328.
 14. Morais, R.J., Ashokka, B., Siau, C. and Ti, L.K. 2014. Simulation of Cardiopulmonary Bypass Management: An Approach to Resident Training. *J. Cardiothorac. Vasc. Anesth.* 28(5): 1387–1392.
 15. Morris, R.W. and Pybus, D.A. 2007. “Orpheus” Cardiopulmonary Bypass Simulation System. *J. Extra Corpor. Technol.* 39: 228–233.
 16. Ninomiya, S., Tokaji, M., Tokumine, A. and Kurosaki, T. 2009. Virtual patient simulator for the perfusion resource management drill. *J. Extra Corpor. Technol.* 41: 206–212.
 17. Ninomiya, S., Tokumine, A., Yasuda, T. and Tomizawa, Y. 2007. Development of an educational simulator system, ECCSIM-Lite, for the acquisition of basic perfusion techniques and evaluation. *J. Artif. Organs.* 10: 201–205.
 18. Ninomiya, S., Tokaji, M., Tokumine, A. and Kurosaki, T. 2011. The virtual patient simulator for the perfusion education in Japan. *Indian J. Extra Corpor. Technol.* 21: 12–17.
 19. Nishida, H., Akazawa, T., Nishinaka, T., Aomi, S., Endo, M. and Koyanagi, H. 1998. Afterload-dependent flow fluctuation of centrifugal pump: should it be actively fixed? *Artif. Organs.* 22(5): 362–365.
 20. Ribeiro, I.B., Ngu, J.M.C., Gill, G. and Rubens, F.D. 2017. Development of a high fidelity pressurized porcine beating heart simulator for cardiac surgery training. *Perfusion.* 32(7): 568–573.
 21. Sestino, J.J., Michaud, N.M., Sievert, A.N. and Shackelford, A.G. 2011. Incorporating high fidelity simulation into perfusion education. *Perfusion.* 26(5): 390–394.
 22. Smelt, J.L.C., Phillips, S., Hamilton, C., Fricker, P., Spray, D., Nowell, J.L., et al. 2016. Simulator Teaching of Cardiopulmonary Bypass Complications: A Prospective, Randomized Study. *J. Surg. Educ.* 73(6): 1026–1031.
 23. Takami, Y., Nakazawa, T., Makinouchi, K., Glueck, J., Benkowski, R. and Nosé, Y. 1997. Mapping of pump efficiency on the pressure-flow curve of a centrifugal blood pump. *Artif. Organs.* 21(8): 953–957.
 24. Tokumine, A., Momose, N. and Tomizawa, Y. 2013. Use of an extracorporeal circulation perfusion simulator: evaluation of its accuracy and repeatability. *J. Artif. Organs.* 16(4): 417–424.
 25. Tokumine, A., Ninomiya, S., Anno, M., Akachi, T., Atarashi, H. and Sato, M. 2008. Educational Simulator “ECCSIM-Lite” Used at the JaSECT Seminar with Analysis of Questionnaire Survey Results. *Japanese J. Extra Corpor. Technol.* 35(3): 343–347.
 26. Tokumine, A., Ninomiya, S., Tokaji, M., Kurosaki, T. and Tomizawa, Y. 2010. Evaluation of Basic Perfusion Techniques, ECCSIM-Lite Simulator. *J. Extra Corpor. Technol.* 42: 139–144.