

Reaction of Silyl Thioketones with Lithium Diethylphosphite: First Observation of Thia-Brook Rearrangement

Kei Takeda,* Koichi Sumi, Susumu Hagiwara

Faculty of Pharmaceutical Sciences, Toyama Medical and Pharmaceutical University,
2630 Sugitani, Toyama 930-0194, Japan

Abstract

Reaction of silyl thioketone **7** with lithium diethylphosphite at $-98\text{ }^{\circ}\text{C}$ afforded an S-attack product **8** and a formal C-attack products **10** and **11**, which were formed by S-to-C migration of the phosphoryl group in **8** followed by C-to-S migration of the silyl group (thia-Brook rearrangement), in a ratio depending on the conditions. The relative facility of the thia-Brook rearrangement was compared with that of the Brook rearrangement using the (*t*-butyldimethylsilyl)diphenylmethyl derivatives **22** and **23**.

Key words:

Inter-element linkage; Silyl thioketone; Thia-Brook rearrangement; Sulfur-phosphorus bond; sulfur-silicon bond

1. Introduction

The reactions of thioketones with nucleophiles have attracted considerable interest because the attack of the nucleophiles can either occur in a thiophilic or carbophilic fashion, depending on the structures of both the thioketones and the nucleophiles [1-3]. Closely related silyl thioketones have only recently emerged as promising synthetic intermediates that allow the synthesis of a variety of compounds containing the Si-C-S unit [4]. Bonini and co-workers reported that the carbon nucleophiles, such as alkyllithium, attack at the sulfur atom in the reaction with silyl thioketone to afford sulfide, a thiophilic attack product [5]. We became interested in exploiting the reaction of silyl thioketones **1** with heteroatom nucleophiles **X**, from the point of view of the direction of attack of the nucleophiles, thiophilic or carbophilic to give **2** and **3**, respectively. And, we were also interested in which the inter-element linkage, S-Si or S-X, is formed in the C-adduct **3** (path a or path b).

We chose *t*-butyldimethylsilyl phenyl thioketone **7** as a silyl thioketone and lithium diethyl phosphite as a nucleophile. The former choice was based on Bonini's finding that the corresponding trimethylsilyl derivative was relatively unstable [5].

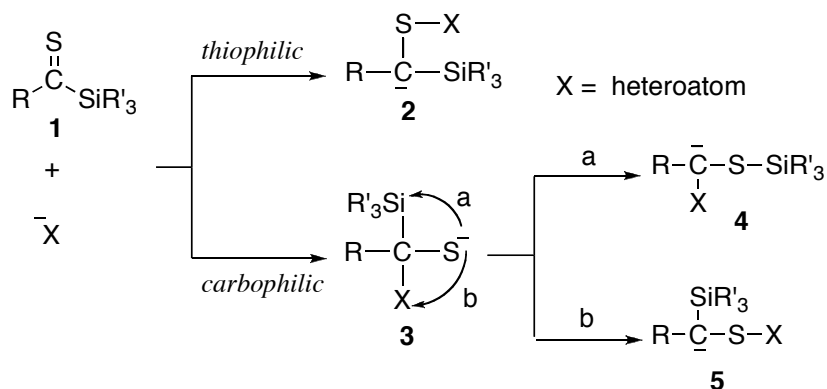

Scheme 1

2. Results and discussion

2.1. Synthesis of silyl thioketone

This compound was prepared by a procedure of Bonini [5] as described for the corresponding trimethylsilyl derivative. Treatment of acylsilyl compound **6** with HCl/H₂S afforded relatively stable silyl thioketone **7** in 90% yield. Blue-colored **7** could be stored in a freezer for a few days without significant decomposition.

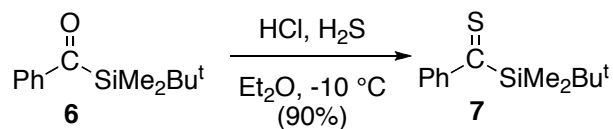

Scheme 2

2.2. Reaction of silyl thioketone with lithium diethylphosphite

When a solution of lithium diethylphosphite in THF, generated from the reaction of diethyl phosphite with *n*-butyllithium, was added to a solution of silyl thioketone **7** in THF at -98 °C (MeOH-liq. N₂) and then stirred at the same temperature for 1 min, a thiophilic attack product **8** was obtained in 61% yield (Table 1, entry 1). The structure of **8** was verified by NMR comparison of its desilylation product by *n*-Bu₄NF with the compound derived from phosphorylation of phenylmethanethiol. Prolonged reaction times and/or elevated reaction temperatures (-30 °C) resulted in lower yields of **8** due to the formation of unidentified decomposition products. The effect of changing the solvent polarity was briefly examined. Although the reaction was not sensitive to changing from THF to toluene (entry 5), the use of THF-HMPA (9:1) resulted in a lower yield of **8** (Table 1, entry 6).

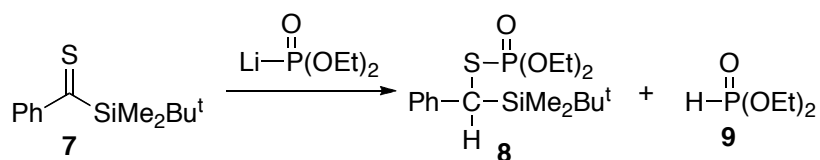

entry	solvent	temperature (°C)	time (min)	yield (%)	
				8	9
1	THF	-98	1	61	26
2	THF	-98	10	57	10
3	THF	-98	30	36	43
4	THF	-98	60	25	22
5	toluene	-84	10	52	-
6	THF-HMPA (9:1)	-98	10	29	40

Table 1

When the order of the addition was reversed (silylthio ketone added to phosphite), however, it resulted in the formation of compound **10**, a product formally arising from C-attack followed by C-to-O 1,2-anionic rearrangement of the silyl group, and/or its hydrolysis product **11**, in addition to **8** (Table 2).

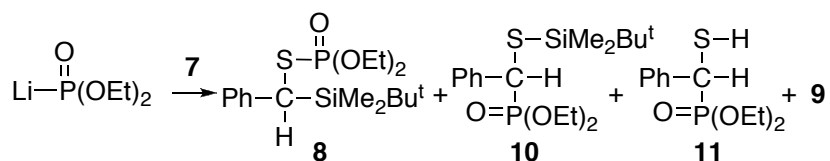

entry	solvent	temp (°C)	time (min)	yield (%)			
				8	10	11	9
1	THF	-98	10	21	-	14	16
2	THF	-98	30	19	2	18	20
3	toluene	-84	10	40	7	11	-
4	THF-HMPA (9:1)	-98	10	29	-	-	40

Table 2

The structure of **11** was determined on the basis of its ¹³C NMR and ¹H NMR spectra to be a carbon-phosphorus geminal coupling with *J* = 148.2 Hz at 38.4 ppm, and a doublet of doublets peak of the SH proton at 2.64 ppm (dd, *J* = 18.8, 8.1 Hz). Also, **11** was silylated by TBSCl to give **10**. In order to examine whether **10** arises directly from a carbophilic attack of the phosphite or from an S-attack of the nucleophile followed by an S-to-C rearrangement of the phosphoryl group and then C-to-S migration of the silyl group, we carried out the reaction of **7** with a catalytic amount of lithium diethylphosphite in the presence of diethyl phosphite, anticipating that the carbanion or thioxide anion resulting from the initial attack of the nucleophile would be immediately protonated by the phosphorous acid. When **7** was treated with 0.1 equiv. of lithium diethylphosphite and 0.9 equiv. of

diethyl phosphite, irrespective of the order of addition, **8** was the only isolated product and neither **10** nor **11** was detected. These results suggest that the initial attack of the nucleophile occurs at the sulfur atom and then the phosphoryl group migrates from S to O depending on the reaction conditions. To verify the feasibility of the rearrangement of the phosphoryl group, we examined the deprotonation of **8** by a variety of bases. Although the use of most bases including LDA, *n*-butyllithium, and *t*-butyllithium, resulted in recovery of the starting material or in attack at the phosphoryl group followed by cleavage of the P-S bond, reaction of **8** with MeLi afforded **11**, formed via S-to-C migration followed by thia-Brook rearrangement, in 16% yield in addition to **12** and **13**.

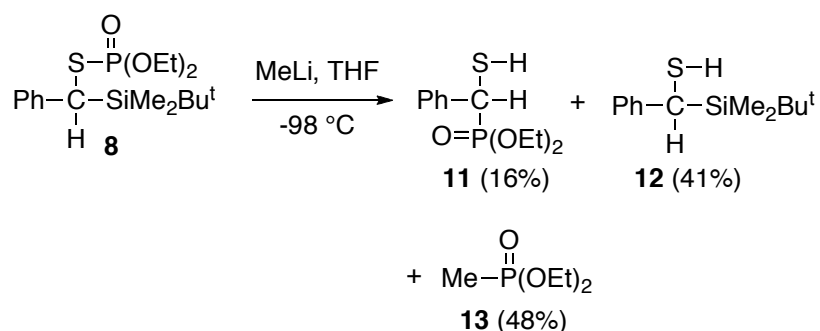

Scheme 3

Although the origin of the difference in product distribution depending on the order of addition and the precise mechanism are not clear at the present time, it is reasonable to assume that the reaction path involves the initial attack of the phosphoryl group at the sulfur atom followed by an S-to-O migration of the phosphoryl group and a C-to-S migration of the silyl group (thia-Brook rearrangement).

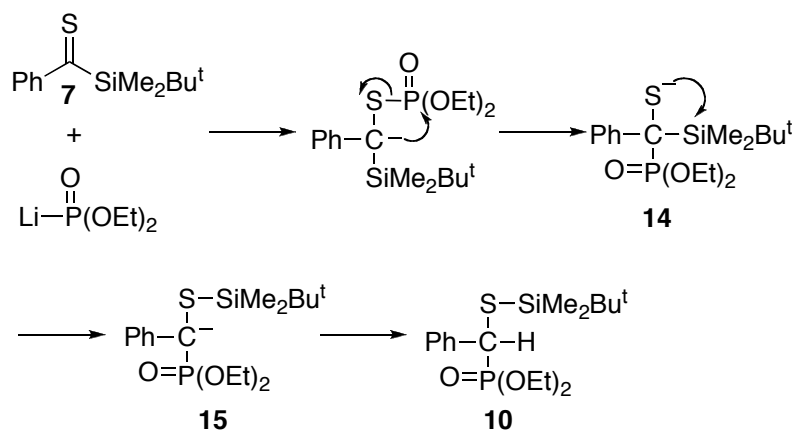

Scheme 4

In order to test the feasibility of the unprecedented thia-Brook rearrangement [6], we attempted to trap **14** and to prepare **16** by silylation (base/TBSCl) of **10** followed by desilylation, but we had no success.

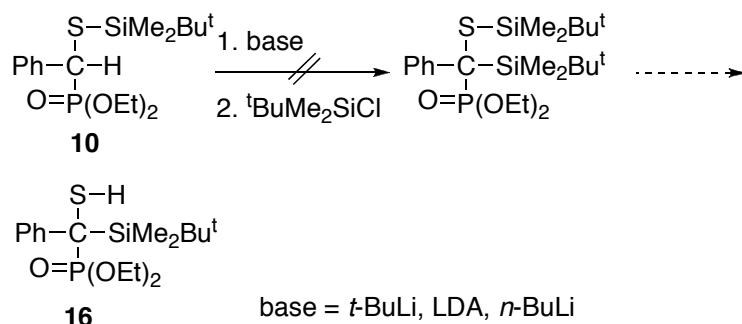

Scheme 5

Next, we decided to examine the possibility of the thia-Brook rearrangement occurring at a reasonable rate at $-98\text{ }^\circ\text{C}$ using a simpler model system.

2.3. Thia-Brook rearrangement of (*tert*-butyldimethylsilyl)diphenylmethanethiol to *tert*-butyldimethylsilyl diphenylmethyl sulfide

West reported that treatment of benzyl trimethylsilyl sulfide (**17**) with *t*-BuLi at $-78\text{ }^\circ\text{C}$ afforded α -(trimethylsilyl)phenylmethanethiol (**18**) in 90% yield and that its reverse rearrangement occurred only under radical conditions [7].

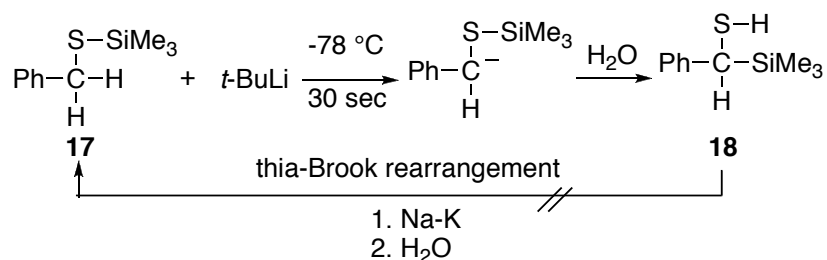

Scheme 6

We envisaged that replacement of the hydrogen atom by a phenyl group in **18** would produce an increase in the rate of occurrence of the thia-Brook rearrangement, because Brook reported that the change from a hydrogen atom to a phenyl group resulted in rate enhancement by factors of 1000 in the oxygen counterpart [8]. When (*tert*-butyldimethylsilyl)diphenylmethanethiol (**21**), prepared from diphenylmethanethiol **19** [9] via the silylation-desilylation sequence, was treated with MeLi at $-98\text{ }^\circ\text{C}$ for 10 min, the rearranged product **20** was obtained in 81% yield.

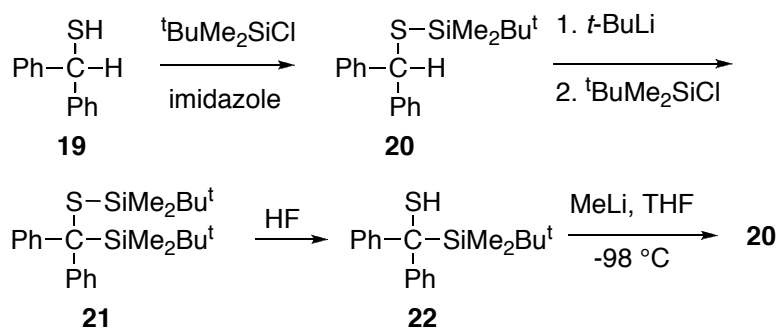

Scheme 7

Next, we compared the relative rates of occurrence of the thia-Brook and Brook rearrangements. Effective reaction conditions for the rearrangement were examined on **21** and **23** using several amine bases in solvents by monitoring using ^1H NMR [8, 10]. The reactions proceeded at a reasonable rate when using 1.0 equiv. of 1,8-diazabicyclo[5.4.0]undec-7-ene (DBU) in CDCl_3 (50 mM) at 23 $^\circ\text{C}$. Under these conditions, the half-lives of the reactions were measured as 11.0 min and 2.4 min for **21** and **23**, respectively.

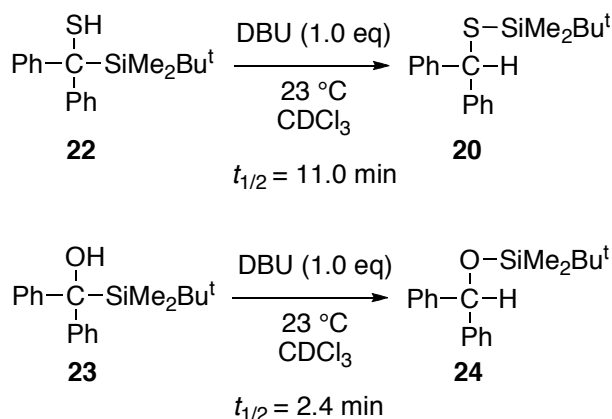

Scheme 8

These results indicate that the thia-Brook rearrangement can occur at a reasonable rate when the generated carbanion can be stabilized by two phenyl groups, and they suggest the possibility of the thia-Brook rearrangement from **14** to **15** in which the carbanion is stabilized by a phenyl group and a phosphoryl group. The difference between the rates of occurrence of the thia-Brook and Brook rearrangements can be interpreted as the result of a balance between the strengths of S-Si and O-Si and the relative stabilities of the anions involved.

In conclusion, we have demonstrated that the reaction of silyl thioketone with lithium diethylphosphite can proceed via a thiophilic attack followed by S-to-C migration of the phosphoryl group and the thia-Brook rearrangement, C-to-S migration, of the silyl group. Moreover, we have

shown that the unprecedented thia-Brook rearrangement is slower by a factor of about 5 relative to the oxygen counterpart.

3. Experimental

IR spectra were recorded on a Perkin-Elmer FT1640 spectrometer. ^1H NMR spectra were taken on Varian UnityPlus 500 (500 MHz) and Varian Gemini 300 (300 MHz) in CDCl_3 with reference to CHCl_3 (δ 7.26). ^{13}C NMR spectra were measured with Varian UnityPlus 500 (125 MHz) in CDCl_3 with reference to the CDCl_3 triplet (δ 77.2). Resonance patterns were described as s = singlet, d = doublet, t = triplet, m = multiplet, and br = broad. Low- and high-resolution mass spectra (EI-MS) were obtained with a JEOL JMS-D-300 spectrometer combined with a JEOL JMA-2000 data-processing system. For routine chromatography, the following adsorbents were used: Fuji-Davison silica gel BW-200 (150-325 mesh) for column chromatography; and Merck precoated silica gel 60 F-254 plates for analytical thin-layer chromatography. All moisture-sensitive reactions were performed under a positive pressure of nitrogen. Anhydrous MgSO_4 was used for drying all organic solvent extracts in workup, and the removal of the solvents was performed with a rotary evaporator. Dry solvents and reagents were obtained by using standard procedures.

3.1. *tert*-Butyldimethylsilyl Phenyl thioketone (7)

Hydrogen chloride and hydrogen sulfide were bubbled into a solution of *tert*-butyldimethylsilyl phenyl ketone **6** (600 mg, 2.72 mmol) in Et_2O (22 mL) at $-10\text{ }^\circ\text{C}$ for 5 min. The solution was poured into a mixture of aqueous saturated NaHCO_3 (50 mL) and Et_2O (30 mL). The phases were separated and the aqueous phase was extracted with Et_2O (30 mL x 2). Combined organic phases were washed with water (50 mL), dried, and concentrated. The residual oil was subjected to column chromatography (silica gel, 30 g; elution with hexane) to give **7** (578 mg, 90%), a blue oil, $R_f = 0.36$ (hexane). IR (film) 1250 cm^{-1} . ^1H NMR (500 MHz, CDCl_3) δ 0.39 (6H, s, SiMe_2), 0.91 (9H, s, *t*-Bu), 7.37 (2H, tm, Ar-H), 7.48 (1H, tm, Ar-H), 7.62 (2H, dm, Ar-H). ^{13}C NMR (125 MHz, CDCl_3) δ -2.4 (SiMe_2), 17.6 (CMe_3), 27.2 (*t*-Bu), 125.5, 128.3, 131.2, and 153.7 (Ar), 294.0 (C=S). HRMS calcd for $\text{C}_{19}\text{H}_{36}\text{O}_3\text{Si}_2$ 236.1055, found 236.1087.

3.2.1. General procedure for the reaction of **7** with lithium diethylphosphite

Method A: The following procedure for reaction of **7** at $-98\text{ }^\circ\text{C}$ is representative: To a cooled ($-98\text{ }^\circ\text{C}$) solution of **7** (500 mg, 2.12 mmol) in THF (20 mL) was added a cooled ($-98\text{ }^\circ\text{C}$) solution of lithium diethyl phosphite, which was prepared from diethyl phosphite (273 μL , 2.12 mmol) in

THF (1 mL) and *n*-BuLi (1.44 M in hexane, 1.47 mL, 2.12 mmol), by the use of cannula over a period of 1 min. The solution was stirred for 60 min at the same temperature and then quenched by the addition of a solution of AcOH (120 μ L, 2.12 mmol) in THF (1 mL). The mixture was passed through a short pad of silica gel and concentrated. The residual oil was subjected to column chromatography (silica gel, 30 g; elution with 2:1 hexane-AcOEt) to give **8** (452 mg, 57%) and **9** (29 mg, 10%). **8**: a colorless oil, R_f = 0.46 (hexane: AcOEt = 3 : 1). IR (film) 1250, 1020 cm^{-1} . ^1H NMR (500 MHz, CDCl_3) δ -0.11, 0.19 (each 3H, s, SiMe_2), 0.85 (9H, s, *t*-Bu), 1.02, 1.12 (each 3H, t, J = 7.1 Hz, OCH_2CH_3), 3.52-3.60 (1H, m, OCH_2), 3.73 (1H, d, J = 16.7 Hz, CH), 3.74-3.99 (3H, m, OCH_2), 7.10-7.13 (1H, m, Ar-H), 7.21-7.26 (4H, m, Ar-H). ^{13}C NMR (125 MHz, CDCl_3) δ -6.7, -6.4 (SiMe_2), 15.8, 16.0 (OCH_2CH_3), 18.0 (CMe_3), 27.0 (*t*-Bu), 35.4 (CH), 63.2 (OCH_2), 126.1, 128.3, 128.4, and 142.7 (Ar). HRMS calcd for $\text{C}_{17}\text{H}_{31}\text{O}_3\text{PSSi}$ 374.1501, found 374.1463.

Method B: The following procedure is representative: To a cooled (-98 $^\circ\text{C}$) solution of lithium diethyl phosphite, which was prepared from diethyl phosphite (274 μ L, 2.12 mmol) in THF (20 mL) and *n*-BuLi (1.44 M in hexane, 1.47 mL, 2.12 mmol), was added **7** (500 mg, 2.12 mmol) in THF (1 mL) by the use of cannula over a period of 1 min. The solution was stirred for 30 min at the same temperature and then quenched by the addition of a solution of AcOH (121 μ L, 2.12 mmol) in THF (1 mL). The mixture was passed through a short pad of silica gel and concentrated. The residual oil was subjected to column chromatography (silica gel, 30 g; elution with 2:1 hexane-AcOEt) to give **8** (152 mg, 19%), **10** (2%, calculated from ^1H NMR integration), **11** (100 mg, 18%), (72 mg, 25%), and **9** (47 mg, 16%). **10**: a colorless oil, R_f = 0.39 (hexane: AcOEt = 1 : 1). IR (film) 1250, 1025 cm^{-1} . ^1H NMR (500 MHz, CDCl_3) δ 0.01, 0.25 (each 3H, s, SiMe_2), 0.91 (9H, s, *t*-Bu), 1.12, 1.29 (each 3H, t, J = 7.1 Hz, OCH_2CH_3), 3.74-3.79 (1H, m, OCH_2), 3.96-4.01 (1H, m, OCH_2), 4.01 (1H, d, J = 21.6 Hz, CH), 4.11-4.19 (2H, m, OCH_2), 7.22-7.31 (3H, m, Ar-H), 7.46-7.48 (2H, m, Ar-H). ^{13}C NMR (125 MHz, CDCl_3) δ -3.6, -3.3 (SiMe_2), 16.4, 16.6 (OCH_2CH_3), 19.1 (CMe_3), 26.4 (*t*-Bu), 40.9 (d, J = 148.2 Hz, CH), 63.6, 63.7 (OCH_2), 127.7, 128.4, 129.6, and 138.1 (Ar). HRMS calcd for $\text{C}_{17}\text{H}_{31}\text{O}_3\text{PSSi}$ 374.1501, found 374.1512. **11**: a colorless oil, R_f = 0.32 (hexane: AcOEt = 1 : 2). IR (film) 1250, 1025 cm^{-1} . ^1H NMR (500 MHz, CDCl_3) δ 1.12, 1.32 (each 3H, t, J = 7.1 Hz, OCH_2CH_3), 2.64 (1H, dd, J = 10.9, 8.1 Hz, SH) 3.77-3.87 (1H, m, OCH_2), 3.95-4.03 (1H, m, OCH_2), 4.08 (1H, dd, J = 18.8, 8.1 Hz, CH), 4.12-4.21 (2H, m, OCH_2), 7.28 (1H, tm, J = 7.5 Hz, Ar-H), 7.33 (2H, tm, J = 7.5 Hz, Ar-H), 7.45 (2H, dm, J = 7.5 Hz, Ar-H). ^{13}C NMR (125 MHz, CDCl_3) δ 16.4, 16.6 (OCH_2CH_3), 38.4 (d, J = 148.2 Hz, CH), 63.7, 63.8 (OCH_2), 128.2, 128.8, 129.0, and 136.6 (Ar). HRMS calcd for $\text{C}_{11}\text{H}_{17}\text{O}_3\text{PS}$ 260.0636, found 260.0654.

3.2.2. Reaction of **8** with methylolithium

To a cooled (-98 °C) solution of **8** (185 mg, 494 μmol) in THF (5 mL) was added MeLi (0.37 M, 1.34 mL, 496 μmol). After being stirred at the same temperature for 15 min, the reaction was quenched by the addition of AcOH (29 μL, 507 μmol). The mixture was passed through a short pad of silica gel and concentrated. The residual oil was subjected to column chromatography (silica gel, 18 g; elution with 1:1 hexane-AcOEt) to give **11** (21 mg, 16%), **12** (48 mg, 41%), and **13** (48%, calculated from ¹H NMR integration)

3.3.1. *tert*-Butyldimethylsilyl diphenyl sulfide (**20**)

To a solution of diphenylmethanethiol (**19**) (1.63 g, 8.14 mmol) in CH₂Cl₂ (20 mL) was added *tert*-butyldimethylsilylchloride (1.48 g, 9.77 mmol), Et₃N (1.48 mL, 10.6 mmol), and DMAP (399 mg, 3.26 mmol). After being stirred at room temperature for 3 h, the solution was diluted with CH₂Cl₂ (5 mL) and washed with water (20 mL). The aqueous phase was extracted with CH₂Cl₂ (20 mL x 3), and combined organic phases were washed with saturated aqueous NH₄Cl (40 mL), and then concentrated. The residual oil was subjected to column chromatography (silica gel, 250 g; elution with hexane: Et₂O = 50 : 1) to give **20** (2.15 g, 84%). a colorless oil, *R_f* = 0.64 (hexane: Et₂O = 10 : 1). ¹H NMR (500 MHz, CDCl₃) δ 0.14 (6H, s, SiMe₂), 0.95 (9H, s, *t*-Bu), 5.26 (1H, s, CH), 7.22 (2H, t, *J* = 7.7 Hz, Ar-H), 7.32 (4H, t, *J* = 7.7 Hz, Ar-H), 7.49 (4H, t, *J* = 7.7 Hz, Ar-H). ¹³C NMR (125 MHz, CDCl₃) δ -3.4 (SiMe₂), 19.0 (CMe₃), 26.5 (*t*-Bu), 49.9 (CH), 126.9, 128.2, 128.5, and 144.6 (Ar). HRMS calcd for C₁₉H₂₆SSi 314.1525, found 314.1544.

3.3.2. (*tert*-Butyldimethylsilyl)diphenylmethanethiol (**22**)

To a cooled (-80 °C) solution of **20** (2.98 g, 9.48 mmol) in THF (12 mL) was added *n*-BuLi (1.40 M in hexane, 6.80 mL, 9.48 mmol), and the solution was stirred at the same temperature for 15 min before the addition of *tert*-butyldimethylsilylchloride (1.43 g, 9.48 mmol) in THF. The solution was allowed to warm to 0 °C, diluted with saturated aqueous NH₄Cl (20 mL), and then extracted with Et₂O (20 mL x 3). Combined organic phases were washed with saturated brine (40 mL), dried, and concentrated. The residual oil was subjected to column chromatography (silica gel, 400 g; elution with hexane: Et₂O = 50 : 1) to give **21** (2.20 g, 55%) and **20** (1.16 g, 39%).

To a solution of **21** (2.20 g, 5.13 mmol) in CH₂Cl₂ (51 mL) was added an excess of 5% HF in MeCN, and the solution was stirred at room temperature for 90 min. The mixture was poured into saturated aqueous NaHCO₃ solution and then extracted with Et₂O (50 mL x 3). Combined organic phases were successively washed with H₂O (50 mL) and saturated brine (50 mL), dried, and concentrated. The residual oil was subjected to column chromatography (silica gel, 170 g; elution with hexane: Et₂O = 50 : 1) to give **22** (1.44 g, 90%). a colorless oil, *R_f* = 0.32 (hexane). IR (film)

1595, 1490, 1255 cm^{-1} . ^1H NMR (500 MHz, CDCl_3) δ 0.44 (6H, s, SiMe_2), 0.69 (9H, s, *t*-Bu), 2.19 (1H, s, SH), 7.19 (2H, t, $J = 7.3$ Hz, Ar-H), 7.27 (4H, t, $J = 7.3$ Hz, Ar-H), 7.43 (4H, t, $J = 7.3$ Hz, Ar-H). ^{13}C NMR (125 MHz, CDCl_3) δ -2.9 (SiMe_2), 20.1 (CMe_3), 28.2 (*t*-Bu), 47.7 (C-S), 126.1, 128.0, 129.3, and 148.3 (Ar). HRMS calcd for $\text{C}_{19}\text{H}_{26}\text{SSi}$ 314.1525, found 314.1553.

3.3.3. Reaction of **22** with MeLi

To a cooled (-98 °C) solution of **22** (133 mg, 424 μmol) in THF (3.9 mL) was added MeLi (1.14 M in Et_2O , 372 μL , 424 μmol). After being stirred at the same temperature for 10 min, the reaction was quenched by the addition of AcOH (24.3 μL , 424 μmol) in THF (1 mL). The mixture was diluted with saturated aqueous NH_4Cl (20 mL), and extracted with Et_2O (20 mL x 3). Combined organic phases were washed with saturated brine (40 mL), dried, and concentrated. The residual oil was subjected to column chromatography (silica gel, 20 g; elution with 60:1 hexane- Et_2O) to give **20** (107 mg, 81%).

3.3.4. Thia-Brook Rearrangement of **22** into **20** with DBU

22 (14.9 mg, 47.4 μmol) was dissolved in CDCl_3 (877 μL) in an NMR tube, and 10% DBU solution in CDCl_3 (70.9 μL , 47.4 μmol) was added. The ^1H NMR (300 MHz) was recorded at intervals of ca. 30 s at 23 °C. Half-live values were determined by following the disappearance of a peak at 2.19 ppm assigned as SH in **22** and the appearance of a peak at 5.26 ppm assigned as CH in **20**.

3.3.5 (*tert*-Butyldimethylsilyl)diphenylmethanol (**23**)

To a cooled (-80 °C) solution of **6** (960 mg, 4.36 mmol) in toluene (2 mL) was added dropwise PhLi (1.04 M in cyclohexane-diethylether, 4.20 mL, 4.36 mmol). The reaction was immediately quenched by addition of AcOH (250 μL , 4.36 mmol) in THF (1 mL). The mixture was diluted with saturated aqueous NH_4Cl (20 mL), and extracted with Et_2O (20 mL x 3). Combined organic phases were washed with saturated brine (40 mL), dried, and concentrated. The residual oil was subjected to column chromatography (silica gel, 150 g; elution with 25:1 hexane-AcOEt) to give **23** (262 mg, 20%). a colorless oil, $R_f = 0.48$ (hexane:AcOEt = 10 : 1). IR (film) 3520 cm^{-1} . ^1H NMR (500 MHz, CDCl_3) δ 0.20 (6H, s, SiMe_2), 0.80 (9H, s, *t*-Bu), 2.08 (1H, s, OH), 7.21 (2H, t, $J = 7.3$ Hz, Ar-H), 7.33 (4H, t, $J = 7.3$ Hz, Ar-H), 7.51 (4H, t, $J = 7.3$ Hz, Ar-H). ^{13}C NMR (125 MHz, CDCl_3) δ -5.0 (SiMe_2), 19.0 (CMe_3), 28.3 (*t*-Bu), 77.0 (C-OH), 126.2, 126.2, 128.1, and 147.0 (Ar). HRMS calcd for $\text{C}_{19}\text{H}_{26}\text{OSi}$ 298.1753, found 298.1775.

3.3.6. Brook Rearrangement of **23** into **24** with DBU

23 (13 mg, 44.6 μmol) was dissolved in CDCl_3 (825 μL) in an NMR tube, and 10% DBU solution in CDCl_3 (66.7 μL , 44.6 μmol) was added. The ^1H NMR (300 MHz) was recorded at an interval of ca. 30 s at 23 $^\circ\text{C}$. Half-life values were determined by following the disappearance of a peak at 0.80 ppm assigned as *t*-Bu in **23** and the appearance of a peak at 0.97 ppm assigned as *t*-Bu in **24**. **24**: a colorless oil, $R_f = 0.67$ (hexane: AcOEt = 20 : 1). ^1H NMR (500 MHz, CDCl_3) δ 0.03 (6H, s, SiMe_2), 0.97 (9H, s, *t*-Bu), 5.80 (1H, s, CH), 7.24 (2H, t, $J = 7.3$ Hz, Ar-H), 7.32 (4H, t, $J = 7.3$ Hz, Ar-H), 7.40 (4H, t, $J = 7.3$ Hz, Ar-H). ^{13}C NMR (125 MHz, CDCl_3) δ -4.6 (SiMe_2), 18.5 (CMe_3), 26.0 (*t*-Bu), 76.8 (C-O), 126.5, 127.1, 128.3, and 145.4 (Ar). HRMS calcd for $\text{C}_{19}\text{H}_{26}\text{OSi}$ 298.1753, found 298.1737.

Acknowledgments

This research was partially supported by a Grant-in-Aid for Scientific Research on Priority Areas (No. 284, "The chemistry of inter-element linkage") from the Japanese Ministry of Education, Sciences, Sports and Culture.

References

- [1] P. Metzner, *Synthesis* (1992) 1185.
- [2] W.M. McGregor, D.C. Sherrington, *Chem. Soc. Rev.* (1993) 199.
- [3] A. Capperucci, A. Degl'Innocenti, P. Scafato, P. Spagnol, *Phosphorus, Sulfur, and Silicon* 120 (1997) 165.
- [4] B.F. Bonini, *Phosphorus, Sulfur, and Silicon* 74 (1993) 31.
- [5] B.F. Bonini, G. Mazzanti, P. Zani, G. Maccagnani, *J. Chem. Soc. Perkin Trans. 1* (1989) 2083.
- [6] For reviews on the Brook rearrangement, see: (a) M.A. Brook, *Silicon in Organic, Organometallic, and Polymer Chemistry*, John Wiley & Sons, Inc. 2000. (b) A.G. Brook, A.R. Bassindale, *Rearrangements in Ground and Excited States*; de Mayo, P., Ed.; Academic Press: New York, 1980; pp 149. (c) A.G. Brook, *Acc. Chem. Res.* 7 (1974) 77.

- [7] A. Wright, R. West, *J. Am. Chem. Soc.* 96 (1974) 3214.
- [8] A.G. Brook, G.E. LeGrow, D.M. MacRae, *Can. J. Chem.* 45 (1967) 239.
- [9] T. Nishio, *J. Chem. Soc. Perkin 1* (1993) 1113.
- [10] K. Takeda, H. Ubayama, A. Sano, E. Yoshii, T. Koizumi, *Tetrahedron Lett.* 39 (1998) 5243.